

8 7 6 5 4 3 2 1

D





C

B

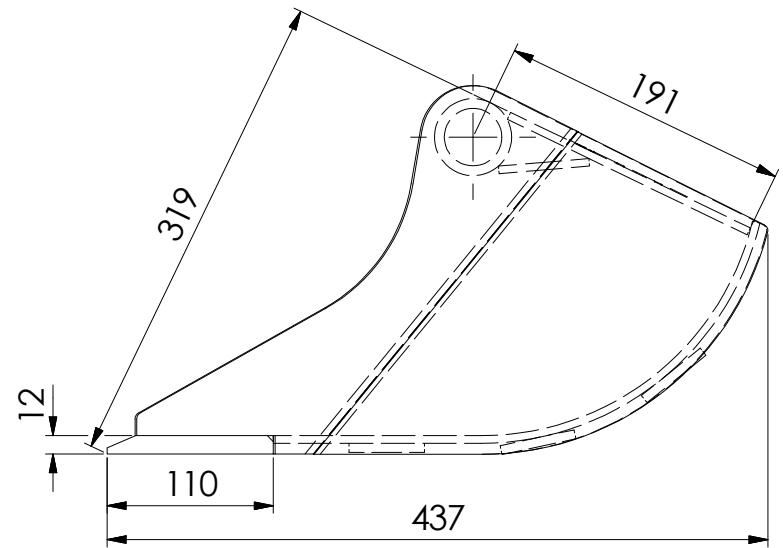
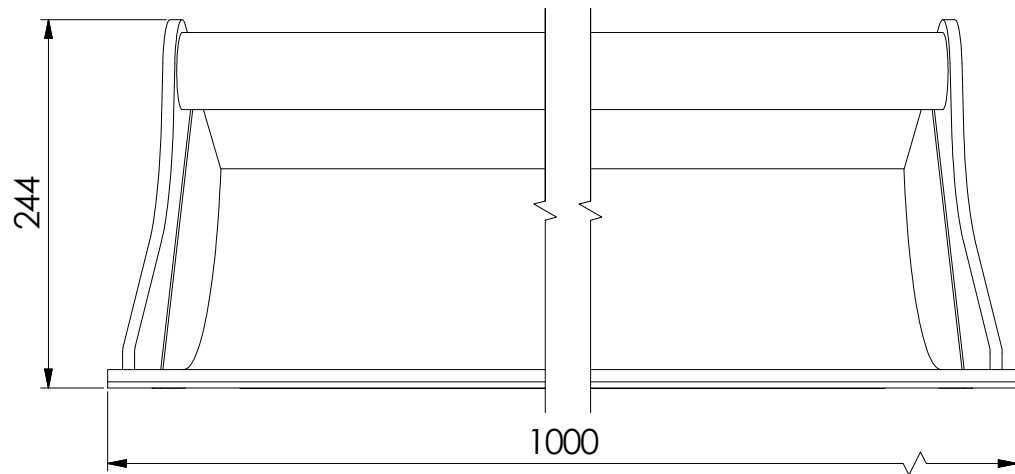
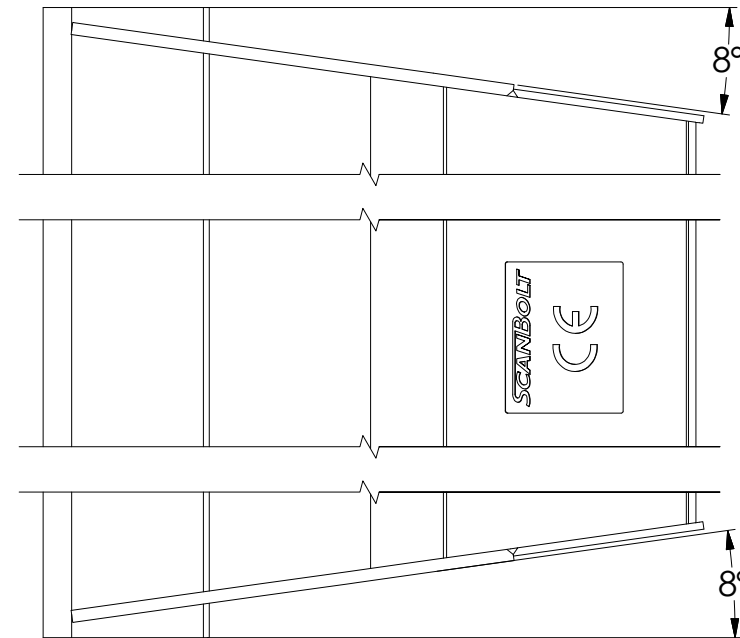
A

8 7 6 5 4 3 2 1



MATERIAL SPECIFICATION	
	ST52.3
	EN8D
	HB 400
	HB 450
	CASTALLOY STEEL

<b>SCANBOLT®</b>	
DESCRIPTION	100CM CLEANING BUCKET
MACHINE CLASS	0.5 - 1.2 TON
WEIGHT	51 Kg
HEAPED CAPACITY	48.1 LITERS